

ML Maximum Power Point Tracking (MPPT) Series ML4860 Solar Charge and Discharge Controller User Manual



Model	ML4860
Battery voltage	12V/24V/36V/48V
Max. solar panel voltage	150V (25°C), 145V (-25°C)
Max. input power	800W/12V; 1600W/24V; 2400W/36V; 3200W/48V
Charging current	60A
Discharging current	20A

Dear users, Thank you for choosing our product!

Safety Instructions

1. As this controller deals with voltages that exceed the top limit for human safety, do not operate it before reading this manual carefully and completing safety operation training.
2. The controller has no internal components that need maintenance or service, thus do not attempt to disassemble or repair the controller.
3. Install the controller indoors, and avoid component exposure and water intrusion.
4. During operation, the radiator may reach a very high temperature, therefore install the controller at a place with good ventilation conditions.
5. It's recommended that a fuse or breaker be installed outside the controller.
6. Before installing and wiring the controller, make sure to disconnect the photovoltaic array and the fuse or breaker close to the battery terminals.
7. After installation, check if all connections are solid and reliable so as to avoid loose connections that may give rise to dangers caused by heat accumulation.

 **Warning:** means the operation in question is dangerous, and you should get properly prepared before proceeding.

 **Note:** means the operation in question may cause damage.

 **Tips:** means advice or instruction for the operator.

Table of Contents

1. Product Introduction	1
1.1 Product Overview	1
1.2 Product Features	1
1.3 Exterior and Interfaces	2
1.4 Introduction to Maximum Power Point Tracking Technology	2
1.5 Charging Stages Introduction	4
2. Product Installation	5
2.1 Installation Precautions	5
2.2 Wiring Specifications	6
2.3 Installation and Wiring	6
3. Product Operation and Display	8
3.1 LED Indicators	8
3.2 Key Operations	9
3.3 LCD Display and Operations	10
3.3.1 Menu Block Diagram	10
3.3.2 Main Menu23	11
3.3.3 Real-Time Monitoring	12
3.3.4 Parameter Settings	13
3.3.5 Controller Charging and Discharging Related Parameters Setting Descriptions	14
3.3.6 LCD Screen Backlight Time Setting	14
3.3.7 "Clear Historical Data" and "Reset to Factory Settings"	14
3.3.8 Load Mode	15
3.3.9 Statistic Data	15
3.3.10 Historical Data of the Current Day	16
3.3.11 Device Information	17
3.3.12 Bluetooth Connection Status	17
4. Product Protection Function and System Maintenance	17
4.1 Protection Functions	17
4.2 System Maintenance	18
5. Product Specification Parameters	19
5.1 Electric Parameters	19
5.2 Battery Type Default Parameters	20
6. Conversion Efficiency Curve	21
6.1 12V System Conversion Efficiency	21
6.1 24V System Conversion Efficiency	21
6.3 48V System Conversion Efficiency	21
7. Product Dimensions	22

1. Product Introduction

1.1 Product Overview

This product can keep monitoring the solar panel's generating power and tracking the highest voltage and current values (VI) in real time, enabling the system to charge the battery in maximum power. It's designed to be used in off-grid photovoltaic systems to coordinate operation of the solar panel, battery and load, functioning as the core control unit in off-grid photovoltaic systems.

This product features an LCD screen which can dynamically display the operating status, operating parameters, controller logs, historical data, control parameters, etc. Users can check parameters using the keys, and modify control parameters to cater to different system requirements.

The controller utilizes standard Modbus communication protocol, making it easy for users to check and modify system parameters on their own. Besides, with the free monitoring software we provide, users' varied remote monitoring needs can be well satisfied.

With comprehensive electronic fault self-detecting functions and powerful electronic protection functions built inside the controller, component damage caused by installation errors or system failures can be avoided to the greatest extent possible.

1.2 Product Features

- ◆ With the advanced dual-peak or multi-peak tracking technology, when the solar panel is shadowed or part of the panel fails resulting in multiple peaks on the I-V curve, the controller is still able to accurately track the maximum power point.
- ◆ A built-in maximum power point tracking algorithm can significantly improve the energy utilization efficiency of photovoltaic systems, and raise the charging efficiency by 15% to 20% compared with the conventional PWM method.
- ◆ A combination of multiple tracking algorithms enables accurate tracking of the optimum working point on the I-V curve in an extremely short time.
- ◆ The product boasts an optimum MPPT tracking efficiency of up to 99.9%.
- ◆ Advanced digital power supply technologies raise the circuit's energy conversion efficiency to as high as 98%.
- ◆ Different charging program options including those for gel batteries, sealed batteries and open batteries, customized ones, etc. are available.
- ◆ The controller features a limited current charging mode. When the solar panel power exceeds a certain level and the charging current is larger than the rated current, the controller will automatically lower the charging power and bring the charging current to the rated level.
- ◆ Instantaneous large current startup of capacitive loads is supported.
- ◆ Automatic recognition of battery voltage is supported.
- ◆ LED fault indicators and an LCD screen which can display abnormality information help users to quickly identify system faults.
- ◆ Historical data storage function is available, and data can be stored for up to a year.
- ◆ The controller is equipped with an LCD screen with which users can not only check device operating data and statuses, but also modify controller parameters.
- ◆ The controller supports standard Modbus protocol, fulfilling the communication needs of various occasions.
- ◆ All communications are electrically isolated, so users can rest assured in usage.
- ◆ The controller employs a built-in over-temperature protection mechanism. When temperature surpasses the set value, the charging current will decline in linear proportion to the temperature and discharging will be halted so as to curb the temperature rise of the controller, effectively keeping the controller from being damaged by overheating.
- ◆ With the help of an external battery voltage sampling function, battery voltage sampling is exempted from the effect of line loss, making control more precise.
- ◆ Featuring a temperature compensation function, the controller can automatically adjust charging and discharging parameters in order to extend the battery's service life.
- ◆ The controller also features a battery over-temperature protection function, and when the external battery temperature exceeds the set value, charging and discharging will be shut off so as to protect components from being damaged by overheating.
- ◆ TVS lighting protection

1.3 Exterior and Interfaces

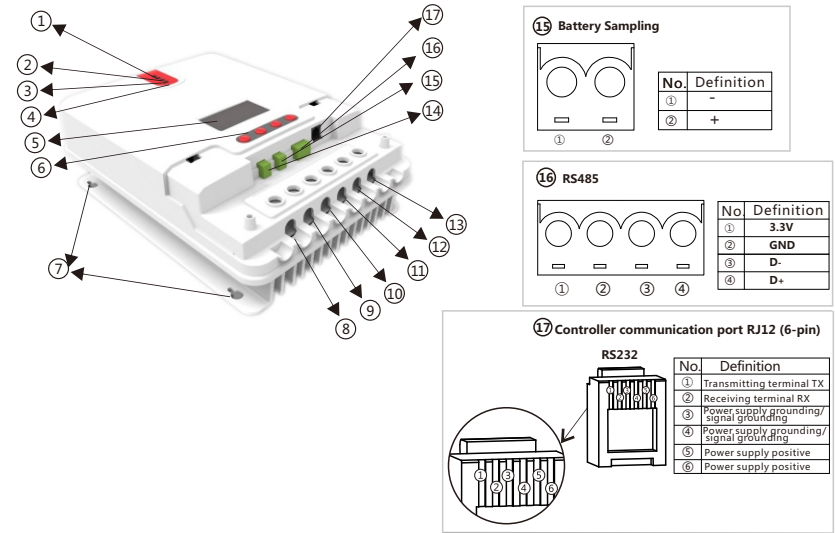

Fig. 1-1 Product appearance and interfaces

No.	Item	No.	Item
①	Charging indicator	⑩	Battery "-" interface
②	Battery indicator	⑪	Load "-" interface
③	Load indicator	⑫	Battery "+" interface
④	Abnormality indicator	⑬	Load "+" interface
⑤	LCD screen	⑭	External temperature sampling interface
⑥	Operating keys	⑮	Battery voltage compensation interface
⑦	Installation hole	⑯	RS485 communication interface
⑧	Solar panel "+" interface	⑰	RS232 communication interface
⑨	Solar panel "-" interface		

1.4 Introduction to Maximum Power Point Tracking Technology

Maximum Power Point Tracking (MPPT) is an advanced charging technology that enables the solar panel to output more power by adjusting the electric module's operating status. Due to the nonlinearity of solar arrays, there exists a maximum energy output point (maximum power point) on their curves. Unable to continuously lock onto this point to charge the battery, conventional controllers (employing switching and PWM charging technologies) can't get the most of the power from the solar panel. But a solar charge controller featuring MPPT technology can continuously track arrays' maximum power point so as to get the maximum amount of power to charge the battery.

Take a 12V system as an example. As the solar panel's peak voltage (V_{pp}) is approximately 17V while the battery's voltage is around 12V, when charging with a conventional charge controller, the solar panel's voltage will stay at around 12V, failing to deliver the maximum power. However, the MPPT controller can overcome the problem by adjusting the solar panel's input voltage and current in real time, realizing a maximum input power.

Compared with conventional PWM controllers, the MPPT controller can make the most of the solar panel's max. power and therefore provide larger charging current. Generally speaking, the latter can raise the energy utilization ratio by 15% to 20% in contrast with the former.

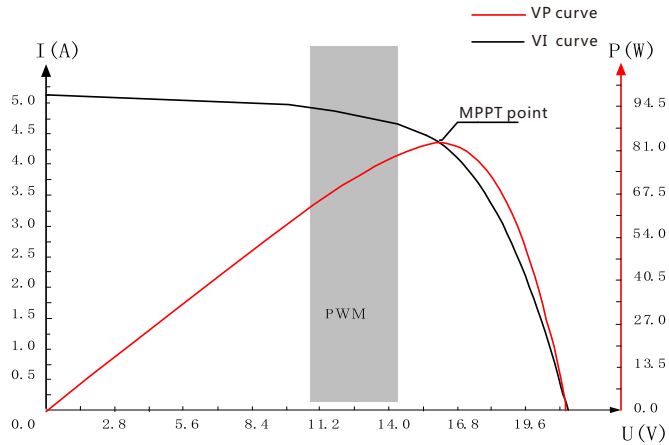

Fig. 1-2 Solar panel output characteristic curve

Meanwhile, due to changing ambient temperature and illumination conditions, the max. power point varies frequently, and our MPPT controller can adjust parameter settings according to the environmental conditions in real time, so as to always keep the system close to the max. operating point. The whole process is entirely automatic without the need of human intervention.

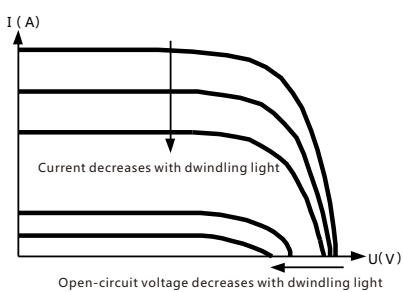

Fig. 1-3 Relation between solar panel output characteristics and illumination

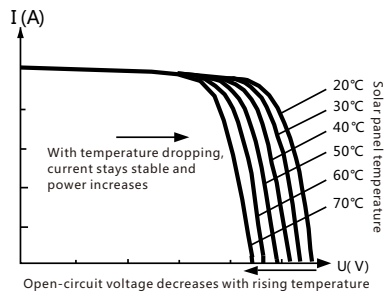

Fig. 1-4 Relation between solar panel output characteristics and temperature

1.5 Charging Stages Introduction

As one of the charging stages, MPPT can't be used alone, but has to be used together with boost charging, floating charging, equalizing charging, etc. to complete charging the battery. A complete charging process includes: fast charging, sustaining charging and floating charging. The charging curve is as shown below:

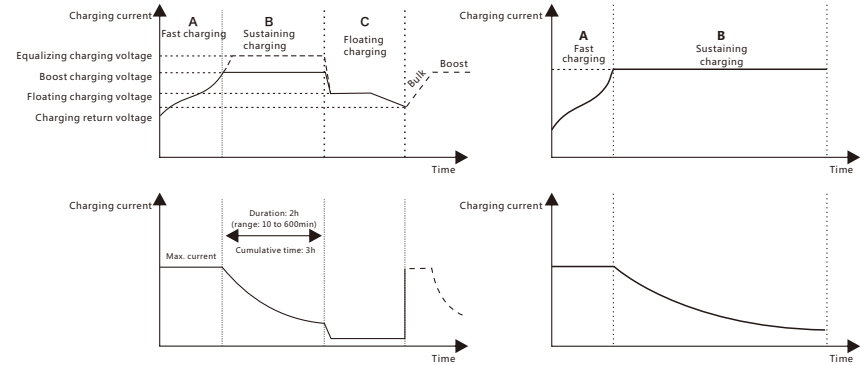

Fig. 1-5 SLD Battery charging stages diagram

Fig. 1-6 LI Battery charging stages diagram

a) Fast charging

At the fast charging stage, as the battery voltage has not reached the set value of full voltage (i.e. equalizing/ boost voltage) yet, the controller will perform MPPT charging on the battery with the maximum solar power. When the battery voltage reaches the preset value, constant voltage charging will begin.

b) Sustaining charging

When the battery voltage reaches the set value of sustaining voltage, the controller will switch to constant voltage charging. In this process, no MPPT charging will be performed, and meanwhile the charging current will also gradually decrease. The sustaining charging stage itself consists of two sub-stages, i.e. equalizing charging and boost charging, the two of which are not carried out in a repeated manner, with the former getting activated once every 30 days.

➤ Boost charging

By default, boost charging generally lasts for 2h, but users can adjust preset values of duration and boost voltage point according to the actual needs. When the duration reaches the set value, the system will then switch to floating charging.

➤ Equalizing charging

⚠ Warning: risk of explosion!

In equalizing charging, an open lead-acid battery can produce explosive gas, therefore the battery chamber shall have good ventilation conditions.

⚠ Note: risk of equipment damage!

Equalizing charging may raise the battery voltage to a level that may cause damage to sensitive DC loads. Check and make sure that allowable input voltages of all the loads in the system are greater than the set value for battery equalizing charging.

⚠ Note: risk of equipment damage!

Overcharge or too much gas generated may damage battery plates and cause active material on the battery plates to scale off. Equalizing charging to an excessively high level or for too long a period may cause damage. Read carefully the actual requirements of the battery deployed in the system.

Some types of batteries benefit from regular equalizing charging which can stir the electrolyte, balance the battery voltage and finish the electrochemical reaction. Equalizing charging raises the battery voltage to a higher level than the standard supply voltage and gasify the battery electrolyte. If the controller then automatically steers the battery into equalizing charging, the charging duration is 120 minutes (default). In order to avoid too much generated gas or battery overheat, equalizing charging and boost charging won't repeat in one complete charging cycle.

Note:

1) When due to the installation environment or working loads, the system can't continuously stabilize the battery voltage to a constant level, the controller will initiate a timing process, and 3 hours after the battery voltage reaches the set value, the system will automatically switch to equalizing charging.

2) If no calibration has been done to the controller clock, the controller will perform equalizing charging regularly according to its internal clock.

➤ Floating charging

When finishing the sustaining charging stage, the controller will switch to floating charging in which the controller lowers the battery voltage by diminishing the charging current and keeps the battery voltage at the set value of floating charging voltage. In the floating charging process, very light charging is carried out for the battery to maintain it at full state. At this stage, the loads can access almost all the solar power. If the loads consume more power than the solar panel could provide, the controller will not be able to keep the battery voltage at the floating charging stage. When the battery voltage drops to the set value for returning to boost charging, the system will exit floating charging and reenter into fast charging.

2. Product Installation

2.1 Installation Precautions

- ◆ Be very careful when installing the battery. For open lead-acid batteries, wear a pair of goggles during installation, and in case of contact with battery acid, flush with water immediately.
- ◆ In order to prevent the battery from being short-circuited, no metal objects shall be placed near the battery.
- ◆ Acid gas may be generated during battery charging, thus make sure the ambient environment is well ventilated.
- ◆ Keep the battery away from fire sparks, as the battery may produce flammable gas.
- ◆ When installing the battery outdoors, take sufficient measures to keep the battery from direct sunlight and rain water intrusion.
- ◆ Loose connections or corroded wire may cause excessive heat generation which may further melt the wire's insulation layer and burn surrounding materials, and even cause a fire, therefore make sure all connections are tightened securely. Wires had better be fixed properly with ties, and when needs arise to move things, avoid wire swaying so as to keep connections from loosening.

- ◆ When connecting the system, the output terminals' voltage may exceed the top limit for human safety. If operation needs to be done, be sure to use insulation tools and keep hands dry.
- ◆ The wiring terminals on the controller can be connected with a single battery or a pack of batteries. Following descriptions in this manual apply to systems employing either a single battery or a pack of batteries.
- ◆ Follow the safety advice given by the battery manufacturer.
- ◆ When selecting connection wires for the system, follow the criterion that the current density is not larger than 4A/mm².
- ◆ Connect the controller's earth terminal to the ground.

2.2 Wiring Specifications

Wiring and installation methods must comply with national and local electrical specifications.

The wiring specifications of the battery and loads must be selected according to rated currents, and see the following table for wiring specifications:

Model	Rated charging current	Rated discharging current	Battery wire diameter (mm ²)	Load wire diameter (mm ²)	Battery voltage compensation wire
M14860	60A	20A	>15	<5	No requirements

2.3 Installation and Wiring

⚠ Warning: risk of explosion! Never install the controller and an open battery in the same enclosed space! Nor shall the controller be installed in an enclosed space where battery gas may accumulate.

⚠ Warning: danger of high voltage! Photovoltaic arrays may produce a very high open-circuit voltage. Open the breaker or fuse before wiring, and be very careful during the wiring process.

⚠ Note: when installing the controller, make sure that enough air flows through the controller's radiator, and leave at least 150 mm of space both above and below the controller so as to ensure natural convection for heat dissipation. If the controller is installed in an enclosed box, make sure the box delivers reliable heat dissipation

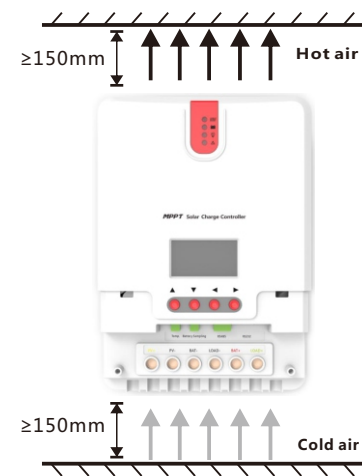

Fig. 2.1 Installation and heat dissipation

Step 1: choose the installation site

Do not install the controller at a place that is subject to direct sunlight, high temperature or water intrusion, and make sure the ambient environment is well ventilated.

Step 2: fit screws in

According to the installation dimensions of the product, use a marker pen to mark the mounting points, then drill 4 mounting holes at the 4 marked points, and fit screws in.

Step 3: fix the controller

Aim the controller's fixing holes at the screws fit in Step 2 and mount the controller on.

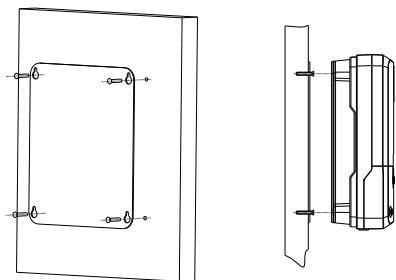

Fig. 2.2 Wiring sequence

Step 4: wire

First remove the two screws on the controller, and then begin wiring operation. In order to guarantee installation safety, we recommend the wiring order as indicated by the numbers in the following diagram (Fig. 2.3); however, you can choose not to follow this order and no damage will be incurred to the controller.

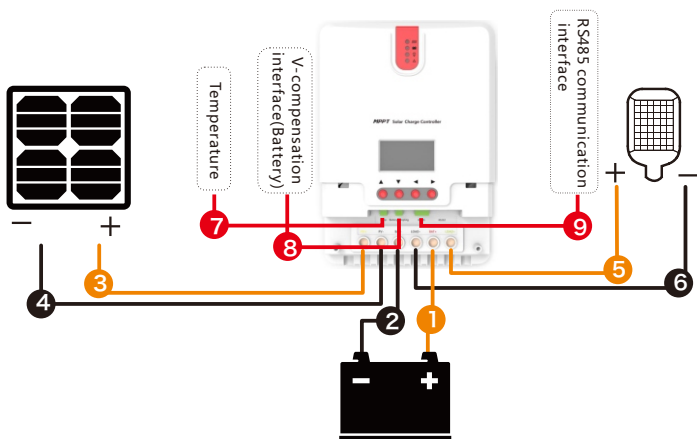

Fig. 2.3 Wiring sequence

① Connecting to external temperature sampling interface and connecting battery voltage compensation cable

② Connecting communication cable

③ Connecting power cable

Warning: risk of electric shock! We strongly recommend that fuses or breakers be connected at the photovoltaic array side, load side and battery side so as to avoid electric shock during wiring operation or faulty operations, and make sure the fuses and breakers are in open state before wiring.

Warning: danger of high voltage! Photovoltaic arrays may produce a very high open-circuit voltage. Open the breaker or fuse before wiring, and be very careful during the wiring process.

Warning: risk of explosion! Once the battery's positive and negative terminals or leads that connect to the two terminals get short-circuited, a fire or explosion will occur. Always be careful in operation.

First connect the battery, then the solar panel, and finally the load. When wiring, follow the order of first "+" and then "-".

④ Power on

After connecting all power wires solidly and reliably, check again whether wiring is correct and if the positive and negative poles are reversely connected. After confirming that no faults exist, first close the fuse or breaker of the battery, then see whether the LED indicators light up and the LCD screen displays information. If the LCD screen fails to display information, open the fuse or breaker immediately and recheck if all connections are correctly done.

If the battery functions normally, connect the solar panel. If sunlight is intense enough, the controller's charging indicator will light up or flash and begin to charge the battery.

After successfully connecting the battery and photovoltaic array, finally close the fuse or breaker of the load, and then you can manually test whether the load can be normally turned on and off. For details, refer to information about load working modes and operations.

Warning: when the controller is in normal charging state, disconnecting the battery will have some negative effect on the DC loads, and in extreme cases, the loads may get damaged.

Note that the battery's fuse or breaker shall be installed as close to the controller as possible, and it's recommended that the installation distance be not more than 150mm.

Note:

1) If no temperature sensor is connected to the controller, the battery temperature value will stay at a default of 25 °C.

2) If an inverter is deployed in the system, directly connect the inverter to the battery, and do not connect it to the controller's load terminals.

3. Product Operation and Display

3.1 LED Indicators

	①--- PV array indicator	Charging mode
	②--- BAT indicator	Battery status
	③--- LOAD indicator	Load status
	④--- ERROR indicator	Abnormality indication

➤ PV array indicator:

NO.	Graph	Indication State	Charging State
①		Steady On	MPPT Charging
②		Slow Flash (On 1s, Off 1s, cycle 2s)	Boost Charging
③		Single Flash (On 0.1s, Off 1.9s, cycle 2s)	Floating Charging
④		Fast Flash (On 0.1s, Off 0.1s, cycle 0.2s)	Equalizing Charging
⑤		Double Flash (On 0.1s, Off 0.1s, On 0.1s, Off 1.7s, cycle 2s)	Current Limited Charging
⑥		Off	Night

➤ BAT indicator:

Indication State	Battery State
Steady On	Battery Voltage Normal
Slow Flash (On 1s, Off 1s, cycle 2s)	Battery Over-Discharge
Fast Flash (On 0.1s, Off 0.1s, cycle 0.2s)	Battery Overvoltage

➤ LOAD indicator:

Indication State	Load state
Off	Load turned off
Fast Flash (On 0.1s, Off 0.1s, cycle 0.2s)	Load overloaded/ short-circuited
Steady On	Load functioning normally

➤ ERROR indicator:

Indicator state	Abnormality indication
Off	System operating normally
Steady on	System malfunctioning

3.2 Key Operations

	Up	Page up; increase the parameter value in setting
	Down	Page down; decrease the parameter value in setting
	Return	Return to previous menu (exit without saving)
	Confirm	Enter into sub-menu; set/ saveTurn on/off loads (in manual mode)

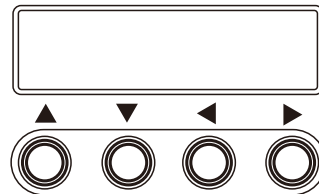

3.3 LCD Display and Operations

3.3.1 Menu Block Diagram

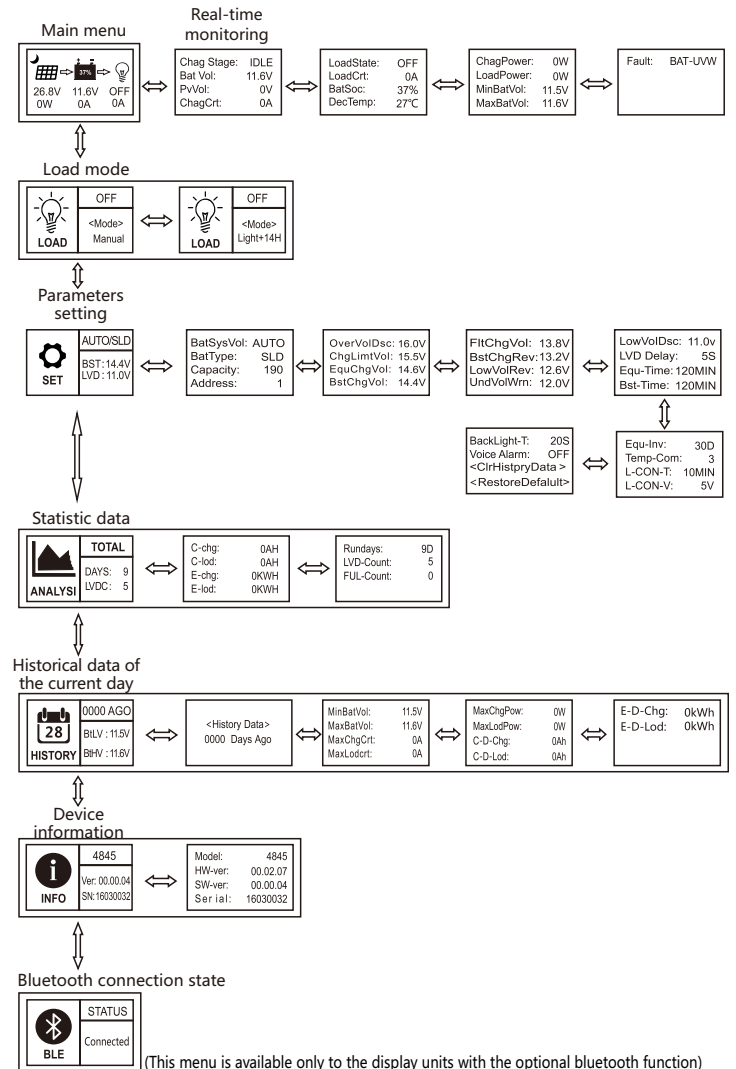

Refer to "Usage of Navigation Keys" for operations including entering into and

3.3.2 Main Menu

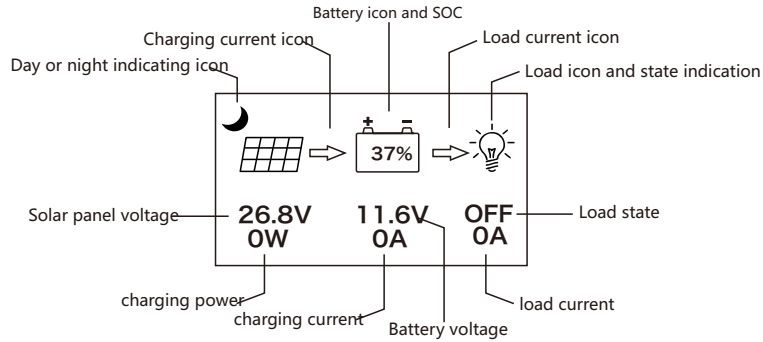

Definitions of "main menu" icons

Icon or value	State	Description	Remarks
	Steady on	Nighttime	Related to charging
	Steady on	Daytime	
	Steady on	A dynamic arrow indicates charging is in process, while a static one indicates otherwise.	Related to battery
	"0~100%"	Current battery capacity	
	"0%" in slow flashing	Battery over-discharged	
	"100%" in quick flashing	Battery over-voltage	
	Steady on	A bulb shown as left and a dynamic arrow indicate the load is switched on.	Related to load
	Steady on	A bulb shown as left and a static arrow indicate the load is switched off.	
	Quick flashing	Overload or short-circuit protection	

3.3.3 Real-Time Monitoring

(This menu is contained in and supplementary to information of the main menu)
 In the "main menu", tap "☞" to enter into this menu; continue to tap "⬆", "⬇" to switch between menus; or tap "⬅" to return to the "main menu".

Menu level	Page	Displayed item/parameter	Description	Remarks
2nd-level menus	1	ChagState: IDLE	Charging state indications: "IDLE", no charging "MPPT", MPPT charging "EQU", equalizing charging "BST", boost charging "FLT", floating charging "LIMIT", current-limited charging	
		BatVol: 11.6V	Battery voltage	
		PvVol: 0V	Solar panel voltage	
	2	ChagCrt: 0A	Charging current	
		LoadState: OFF	Load in "ON" or "OFF" state	
		LoadCrt: 0A	Load current	
		BatSoc: 100%	Remaining battery capacity	
	3	DevTemp: 27 °C	Controller temperature	
		ChagPower: 0W	Charging power	
		LoadPower: 0W	Discharging power	
	4	MinBatVol: 12.5V	The current day's min. battery voltage	
		MaxBatVol: 13.0V	The current day's max. battery voltage	
		Fault: NULL	Controller error codes: "BAT-LDV" over-discharge "BAT-OVD" over-voltage "BAT-UVW" under-voltage warning "L-SHTCRT" load short-circuit "L-OVRCRT" load over-current "DEV-OVRTMP" internal over-temperature "BAT-OVRTMP" battery over-temperature "PV-OVP" solar panel overpower "PV-OC-OVD" solar panel over-voltage "PV-MP-OVD" solar panel working over-voltage	Not every controller has all of these error codes. For details, refer to the User Manual of the corresponding controller.

3.3.4 Parameter Settings

Parameter settings list

Menu level	Page	Item to set	Displayed item/parameter	Parameter and setting range	Remarks
2 st-level menu	1	Battery system voltage	BatSysVol :	"12V" 12Vsystem "24V" 24Vsystem "36V" 36Vsystem "48V" 48Vsystem "AUTO" auto recognition	
		Battery type	BatType :	"SLD" sealed lead-acid battery "FLD" open lead-acid battery "GEL" gel battery "LI" lithium battery "USE" user defined	
		Nominal battery capacity	Capacity :	0~9999	± 5
		Device address	Address :	1~60	± 1
	2	Over-voltage threshold	OverVolDsc	9.0~17.0V	
		Charging limit voltage	ChgLimtVol	9.0~17.0V	
		Equalizing charging voltage	EquChgVol	9.0~17.0V	
		Boost charging voltage	BstChgVol	9.0~17.0V	
	3	Floating charging voltage	FltChgVol :	9.0~17.0V	*n , ±1
		Boost charging recovery voltage	BstChgRev :	9.0~17.0V	
		Over-discharge recovery voltage	LowVolRev :	9.0~17.0V	
		Under-voltage warning level	UndVolWrn :	9.0~17.0V	
	4	Over-discharge voltage	LowVolDsc:	9.0~17.0V	
		Over-discharge time delay	LVD Delay:	0~60s	± 1
		Equalizing charging time	Equ-Time:	0~300 MIN	± 1
	5	Boost charging time	Bst-Time:	0~300 MIN	± 1
		Equalizing charging interval	Equ-Inv :	0~30 D(days)	± 1
		Temperature compensation	Temp-Com :	-(3~5)mV/°C/2V	± 1
		Light control time	L-CON-T:	0~60 MIN	± 1
	6	Light control voltage	L-CON-V:	5~11V	*n , ± 1
		LCD screen backlight time	BackLight-T	1 to 600s (ON indicates the screen is lit constantly)	± 1
		Fault voice alarm;	Voice Alarm :	"ON", voice alarm enabled "OFF", voice alarm disabled	
		Clear historical data	<ClrHistoryData>	Select "YES" for execution	
	Reset to factory settings	<Restore Default>	Select "YES" for execution		

Note:

- 1) In this manual, "n" assigned with a value of 1, 2, 3 or 4 denotes a battery system of 12V, 24V, 36V or 48V accordingly. System voltage indication
- 2) Before setting parameters, first refer to the User Manual of the corresponding controller. As some parameters are not settable, operation of setting these parameters on the display unit will be deemed as invalid or impossible by the controller.

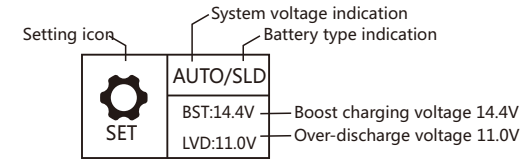

- ① . The "parameters setting" page will have a brief summary of the parameters already set in this menu;
- ② . "AUTO": the battery voltage is the automatic recognition system;
- ③ . "SLD": battery type is sealed lead acid battery;
- ④ . "BST": charging voltage is 14.4V*n;
- ⑤ . "LVD": over-discharge voltage is 11.0V*n;

In the "parameters setting manual, tap "⊙" to enter into the following submenus.

3.3.5 Controller Charging and Discharging Related Parameters Setting Descriptions

- ① . All voltage values are to be set based on 12V system settings. For example, for a 24V system, if the over-discharge voltage is to be set to 22.0V, as n=24/12=2, the value needed in line with 12V system settings is 22.0V/2=11.0V, therefore the over-discharge voltage needs to be set to 11.0V.
- ② . Tap "⊙", "⊙" to select the item to be set; then tap "⊙", and the parameter or sign will flash; continue to tap "⊙", "⊙" to adjust the value, and tap "⊙" again to confirm the setting. (For the setting ranges of related parameters, refer to "Parameter settings list")
- ③ . For parameters on the current menu, those highlighted are settable, while those underlined are not.

3.3.6 LCD Screen Backlight Time Setting

Displayed item/parameter	Description
BackLight-T: ON	The LCD screen is lit constantly
BackLight-T : 20S	The setting range of LCD screen backlight time is 1 to 600s

Enter into the setting menu, tap "⊙", "⊙" to move to "BackLight-T : 20S", tap "⊙" to enter into the setting mode, and tap "⊙", "⊙" to modify the value within the setting range ("ON" indicates the screen will be constantly lit, and the range of backlight time is "1-600" S.). Tap "⊙" to confirm the modification, or tap

"⊙" to cancel the modification.

3.3.7 "Clear Historical Data" and "Reset to Factory Settings"

"ClrHistoryData" --> "YES" clear historical data
 "RestoreDefault" --> "YES" reset to factory settings
 Tap "⊙" to enter into the submenu, and a "NO" and "YES" selection menu will pop up. Use "⊙", "⊙" to select "YES", then tap "⊙" again, and "YES" will flash a few times. If "NO" is selected, tap "⊙" to directly return to the previous level.

3.3.8 Load Mode

Load mode setting icon

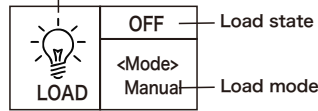

- 1). If the characters displayed on top of "<Mode>" are "ON", it indicates that the load is switched on, and "OFF" indicates the load is switched off.
- 2) . Tap "▶" to enter into the load setting mode, and right below the "<Mode>", the mode characters or digits will begin to flash. Use "▲", "▼" to select any one from the load modes listed in the following table, and tap "▶" again to complete the load mode setting.
- 3). Press and hold "▶" in any menu but not the setting mode: if the current load mode is "manual mode", pressing and holding the key will switch on/ off the load; if the current load mode is not "manual mode", pressing and holding the key will cause the display to skip to the load mode setting interface and a reminder will pop up telling the user in this mode, pressing and holding the key will not switch on/ off the load.
- 4). Note: this parameter is ineffective for controllers without loads.

Load mode	Mode characters	Description
Sole light control mode	Light+On	The solar panel voltage is lower than the light control on voltage, and after a preset time delay , the controller will switch on the load; The solar panel voltage is higher than the light control off voltage, and after a preset time delay , the controller will switch off the load.
Light control + time control mode 1 to 14H	Light+ 01H ... Light+ 14H	The solar panel voltage is lower than the light control on voltage, and after a time delay, the controller will switch on the load. From this point on, the load will work for a preset period of time (1 to 14 hours) before being switched off.
Manual mode	Manual	In this mode, whether it's day or night, users can press and hold the "OK" key to switch on or off the load; this mode is often used in some special occasions or during commissioning.
Debugging mode	Debug	As long as the solar panel voltage is lower than the light control on voltage, the controller will immediately switch on the load; As soon as the solar panel voltage gets higher than the light control off voltage, the controller will immediately switch off the load. This mode is usually used during system installation and commissioning.
Normal on mode	Normal On	This mode is suitable for applications requiring 24-hour operation, and after being switched on, the load keeps outputting in this mode.

3.3.9 Statistic Data

Statistics icon

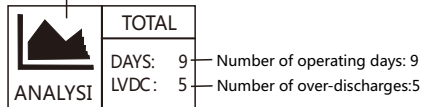

Including total charging amp-hrs, total discharging amp-hrs, total power consumption, numbers of operating days, over-discharges and full-charges

Menu level	Page	Displayed item/ parameter	Description
2nd-level menus	1	C-chg : 0AH	Total charging amp-hrs
		C-lod : 0AH	Total discharging amp-hrs
		E-chg : 0KWH	Total power generation
		E-lod : 0KWH	Total power consumption
	2	Rundays : 10D	Total number of operating days
		LVD-Count : 0	Total number of over-discharges
		FUL-Count : 0	Total number of full-charges

3.3.10 Historical Data of the Current Day

Historical data icon

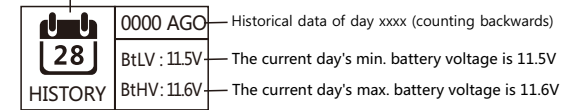

(Historical data including: the current day's min. battery voltage, the current day's max. battery voltage, the current day's max. charging current, the current day's max. discharging current, the current day's max. charging power, the current day's max. discharging power, the current day's charging amp-hrs, the current day's discharging amp-hrs, the current day's total power generation and the current day's total power consumption)

Menu level	Page	Displayed item/ parameter	Description
2st-level menu	1	<History Data> xxxx Days Ago	Xxxx : select the historical data of day xxxx (counting backwards) 0000: the current day 0001: yesterday 0002: the day before yesterday
3st-level menu	1	MinBatVol: 11.5V	The selected day's min. battery voltage
		MaxBatVol: 11.6V	The selected day's max. battery voltage
		MaxChgVol : 0A	The selected day's max. charging current
	2	MaxLodVol : 0A	The selected day's max. discharging current
		MaxChgPow : 0W	The selected day's max. charging power
		MaxLodPow : 0W	The selected day's max. discharging power
3	C-D-Chg : 0AH	The selected day's total charging amp-hrs	
	C-D-Lod : 0AH	The selected day's total discharging amp-hrs	
		E-D-Chg : 0kWh	The selected day's total power generation
		E-D-Lod : 0kWh	The selected day's total power consumption

3.3.11 Device Information

Device information icon

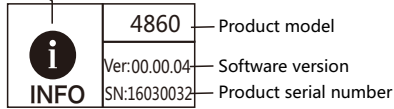

Menu level	Page	Item	Description
2st-level menu	1	Model: 4860	Controller model
		HW-ver: 00.02.07	Hardware version
		SW-ver: 00.00.04	Software version
		Serial: 160300032	Controller serial number

3.3.12 Bluetooth Connection Status

Bluetooth icon

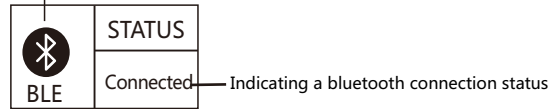

- ① When "Disconnect" is displayed on the screen, it indicates no Bluetooth device is currently connected.
- ② When "Connected", it indicates some Bluetooth device has been connected.
- ③ Bluetooth functions and this menu are only available to the "RM-5B" display unit, and not the "RM-5" unit.
- ④ The App is only compatible with Android phones with an OS version of 4.3 or above and iPhones.

4. Product Protection Function and System Maintenance

4.1 Protection Functions

- **Waterproof**
Waterproof level: Ip32
- **Input power limiting protection**
When the solar panel power exceeds the rated power, the controller will limit the charging power under the rated power so as to prevent excessively large currents from damaging the controller and enter into current-limited charging.
- **Battery reverse connection protection**
If the battery is reversely connected, the system will simply not operate so as to protect the controller from being burned.
- **Photovoltaic input side too high voltage protection**
If the voltage on the photovoltaic array input side is too high, the controller will automatically cut off photovoltaic input.
- **Photovoltaic input side short-circuit protection**
If the photovoltaic input side gets short-circuited, the controller will halt charging, and when the short circuit issue gets cleared, charging will automatically resume.
- **Photovoltaic input reverse-connection protection**
When the photovoltaic array is reversely connected, the controller will not break down, and when the connection problem gets solved, normal operation will resume.

➤ Load overpower protection

When the load power exceeds the rated value, the load will cut off output after a time delay.

➤ Load short-circuit protection

When the load is short-circuited, the controller can implement protection in a quick and timely manner, and will try to switch on the load again after a time delay. This protection can be carried out up to 5 times a day. Users can also manually address the short circuit problem when finding the load is short-circuited via the abnormality codes on the system data analysis page.

➤ Reverse charging protection at night

This protection function can effectively prevent the battery from discharging through the solar panel at night.

➤ TVS lightning protection.

➤ Over-temperature protection

When the controller temperature exceeds the set value, it will decrease the charging power or halt charging. See the following diagram:

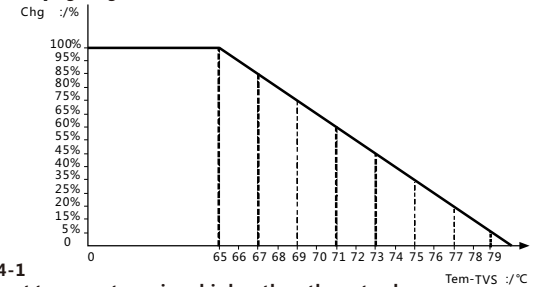

Fig. 4-1
When the ambient temperature rises higher than the set value, the controller will stop charging and discharging.

4.2 System Maintenance

- ◆ In order to keep the controller's performance at its optimum level, we recommend that the following items be checked twice a year.
- ◆ Make sure the airflow around the controller is not blocked and clear away any dirt or debris on the radiator.
- ◆ Check if any exposed wire gets its insulation undermined due to exposure to sunlight, friction with other adjacent objects, dry rot, damage by insects or rodents, etc. Repair or replace those affected when necessary.
- ◆ Verify that indicators function in line with device operations. Note any faults or displayed errors and take corrective measures if necessary.
- ◆ Check all wiring terminals for any sign of corrosion, insulation damage, overheat, combustion/ discoloration, and tighten the terminal screws firmly.
- ◆ Check if there are any dirt, nesting insects or corrosion, and clean as required.
- ◆ If the lightning arrester has lost its efficacy, replace it with a new one timely to prevent the controller and even other devices owned by the user from being damaged by lightning.
- ⚠ **Warning:** risk of electric shock! Before carrying out the above checkings or operations, always make sure all power supplies of the controller have been cut off!

5. Product Specification Parameters

5.1 Electric Parameters

Parameter	Value
Model	ML4860
System voltage	12V/24V/36V/48V Auto
No-load loss	0.7 W to 1.2W
Battery voltage	9V to 70V
Max. solar input voltage	150V (25°C), 145V (-25°C)
Max. power point voltage range	Battery voltage +2V to 120V
Rated charging current	60A
Rated load current	20A
Max. capacitive load capacity	10000uF
Max. photovoltaic system input power	800W/12V; 1600W/24V; 2400W/36V; 3200W/48V
Conversion efficiency	≤ 98%
MPPT tracking efficiency	> 99%
Temperature compensation factor	-3mv/°C/2V (default)
Operating temperature	-35°C to +45°C
Waterproof level	IP32
Weight	3.6kg
Communication method	RS232 RS485
Altitude	≤ 3000m
Product dimensions	285*205*93mm

5.2 Battery Type Default Parameters

Comparison Table of Parameters for Each Type of Battery					
Setting Voltage Battery Type	Sealed Lead-Acid Battery	Gelled Lead-Acid Battery	Open Lead-Acid Battery	LI Battery	User (User-Defined)
Overvoltage Disconnect Voltage	16.0V	16.0V	16.0V	---	9 ~ 17V
Equalizing Voltage	14.6V	---	14.8V	---	9 ~ 17V
Boost Voltage	14.4V	14.2V	14.6V	14.4V	9 ~ 17V
Floating Voltage	13.8V	13.8V	13.8V	---	9 ~ 17V
Boost Restoring Voltage	13.2V	13.2V	13.2V	---	9 ~ 17V
Low Voltage Disconnect Restoring Voltage	12.6V	12.6V	12.6V	12.6V	9 ~ 17V
Under-Voltage Alarming Voltage	12.0V	12.0V	12.0V	---	9 ~ 17V
Low Voltage Disconnect Voltage	11.1V	11.1V	11.1V	11.1V	9 ~ 17V
Discharging Limit Voltage	10.6V	10.6V	10.6V	---	9 ~ 17V
Over-Discharge Delay Time	5s	5s	5s	---	1 ~ 30s
Equalizing Duration Time	120Min	---	120Min	---	0 ~ 600Min
Equalizing Charging Interval	30Days	0Day	30Days	---	0 ~ 250D (0 refers to close equalizing charging function)
Boost Duration Time	120Min	120Min	120Min	---	10 ~ 600Min

When selecting User, the battery type is to be self-customized, and in this case, the default system voltage parameters are consistent with those of the sealed lead-acid battery. When modifying battery charging and discharging parameters, the following rule must be followed:

- ◆ Over-voltage cut-off voltage > Charging limit voltage ≥ Equalizing voltage ≥ Boost voltage ≥ Floating charging voltage > Boost recovery voltage;
- ◆ Over-voltage cut-off voltage > Over-voltage cut-off recovery voltage;
- ◆ Low-voltage cut-off recovery voltage > Low-voltage cut-off voltage ≥ Discharging limit voltage;
- ◆ Under-voltage warning recovery voltage > Under-voltage warning voltage ≥ Discharging limit voltage;
- ◆ Boost recovery voltage > Low-voltage cut-off recovery voltage

6. Conversion Efficiency Curve

6.1 12V System Conversion Efficiency

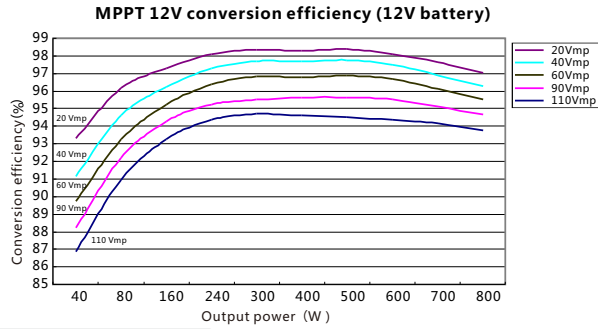

6.1 24V System Conversion Efficiency

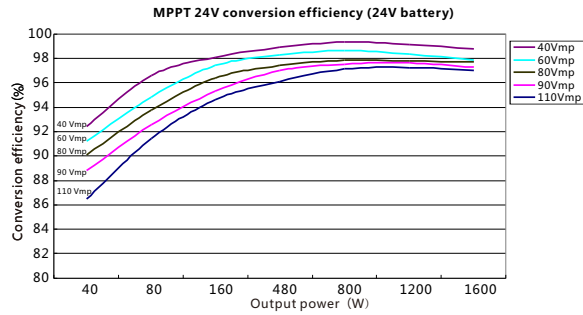

6.3 48V System Conversion Efficiency

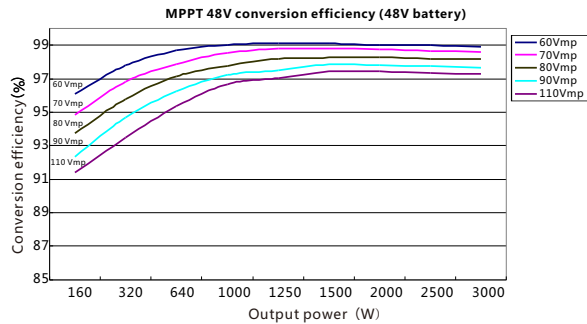

7. Product Dimensions

